

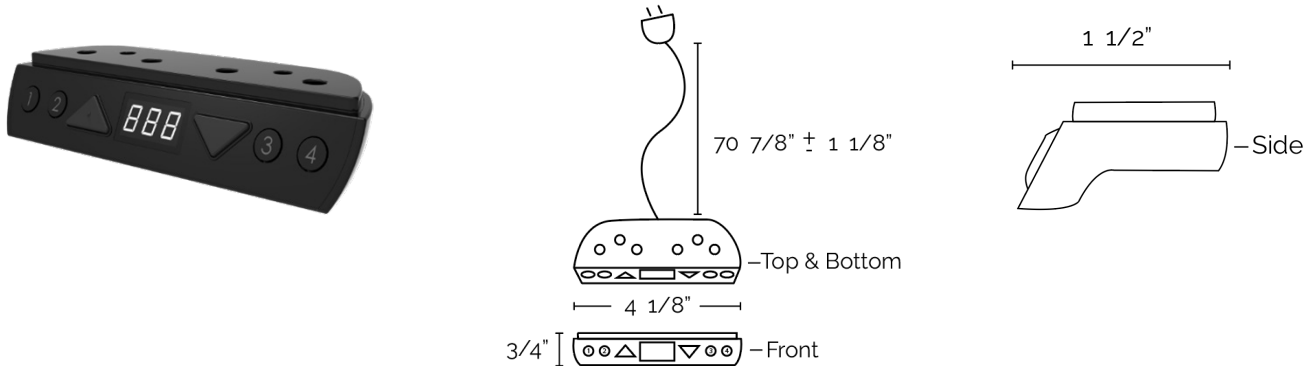

Memory Control Instructions



Premium Electric Adjustable Height Base









RESET *PERFORM RESET BEFORE 1ST USE*

- Press both  and  buttons at the same time until both columns are in lowest position.
- Display will show "000" while conducting reset.
- When control box beeps, the buttons can be released and reset is complete.



NORMAL OPERATION

- Press any button and display shows current height in inches.
- Press  or  button to adjust the height.
- When buttons have not have been pressed for 30 seconds, the system goes to <0.1 W standby mode, and the display turns off. Press any button to wake the system, display will show the current base height.

CHANGING STARTING HEIGHT

- The default starting height is 25".
- To adjust the starting height, press  button until reaching lowest position. At the lowest position, press  button again for 5 seconds until display starts flashing for 10 seconds.
- During this time, press  or  buttons to adjust height to preferred starting position, and then press  and  buttons together for 3 seconds to store this position.
- Display stops flashing and the new starting height is shown in the display.

SETTING & USING MEMORY PRESET POSITIONS

- Operate the desk to preferred height.
- Press any of ①②③④ together with  or  for 2 seconds to store the current height. Display shows P1/P2/P3/P4 when the position has been stored.
- To return table/desk to a stored position, hold the memory preset button ①②③④ until the desk reaches the stored height.
- Memory presets can be overwritten with a new position at any time.